

# wagraf®

DAL 1957

CATALOGO  
PRODOTTI

# 2018



# wagraf®

NOVITÀ

Gentili Signori,  
abbiamo il piacere di presentarvi  
il nostro **nuovo modello**  
**di autoinchiostante tondo *fi 20***.

Il nuovo *fi 20* è disponibile a magazzino.

I tamponi di ricambio si possono avere in 5 colori,  
**nero, blu, rosso, verde, viola** e neutro per auto  
inchiostrazione.

Siamo sicuri che il nuovo *fi20* soddisferà le vostre  
esigenze.

Team Wagraf



# wagraf®

Timbri auto inchiostranti POLAN	2
Timbri auto inchiostranti POLAN grandi	3
Timbri auto inchiostranti WAGRAF b	4
Timbri auto inchiostranti Fi30, Fi40 tondi	5
Tamponi di ricambio	6
Timbri auto inchiostranti sali scendi in plastica	7
Timbri auto inchiostranti sali scendi in metallo HUZAR	8-9
Timbri tascabili in metallo	10
Timbri tascabili in plastica	11
Datari e numeratori auto inchiostranti in plastica DATUS D230, D240	12
Datari auto inchiostranti tondi Fi D40	13
Datari e numeratori auto inchiostranti sali scendi in metallo WAGRAF HUZAR	14
Macchine flash per timbri preink	15
Timbri - Preink Timbro preink in 5 minuti Timbro preink tascabile in 5 minuti	16-17
Timbri manuali in plastica	18-19
Cuscinetti per timbri	20
Timbri in legno a culla e sagome in legno	21
Materiali di consumo	22-24
Le macchine per la produzione dei timbri con fotopolimero	25

# wagraf®

## Timbri auto inchiostranti

### POLAN

POLAN 1s	Compact	28x12mm
POLAN 2		39x15mm
POLAN 2s	Compact	39x15mm
POLAN 3		48x19mm
POLAN 3s	Compact	48x19mm
POLAN 4		59x25mm
POLAN 4s	Compact	59x25mm



POLAN 1s

28x12mm



POLAN 2



POLAN 2s

39x15mm



POLAN 3



POLAN 3s

48x19mm



POLAN 4



POLAN 4s

59x25mm

# POLAN

POLAN 5	70x26mm
POLAN 55	42x34mm
POLAN 6	69x29mm
POLAN 7	60x40mm
POLAN 8	75x40mm

POLAN 5

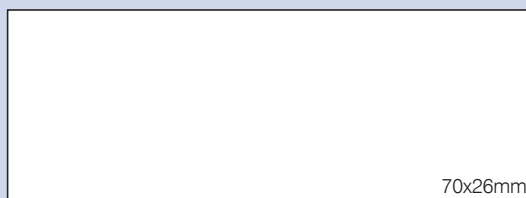

POLAN 55

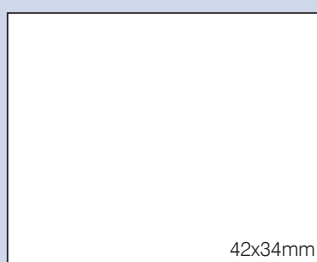

POLAN 6

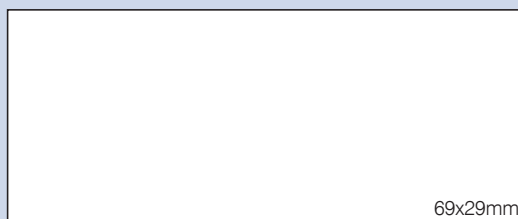

POLAN 7

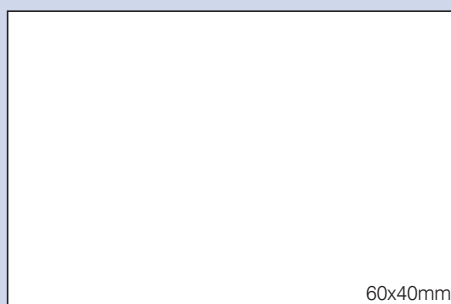

POLAN 8

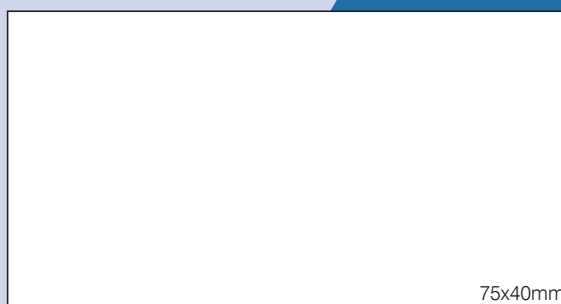

## Timbri auto inchiostranti

WAGRAF  
WAGRAF b

WAGRAF b1s	Compact	28x12mm
WAGRAF b2		39x15mm
WAGRAF b2s	Compact	39x15mm
WAGRAF b3		48x19mm
WAGRAF b3s	Compact	48x19mm
WAGRAF b4		59x25mm
WAGRAF b4s	Compact	59x25mm



WAGRAF b1s

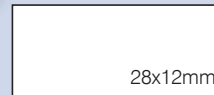

WAGRAF b2s



WAGRAF b2

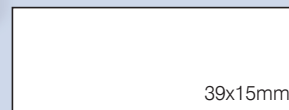

WAGRAF b3s



WAGRAF b3

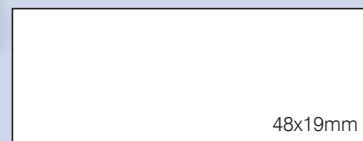

WAGRAF b4s



WAGRAF b4

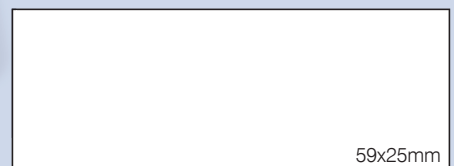

# Montature auto inchiostranti tonde *fi 20, fi 30, fi 40*

**NOVITÀ**

Fi 20	Compact	Ø 20mm
Fi 30	Compact	Ø 30mm
Fi 40	Compact	Ø 40mm

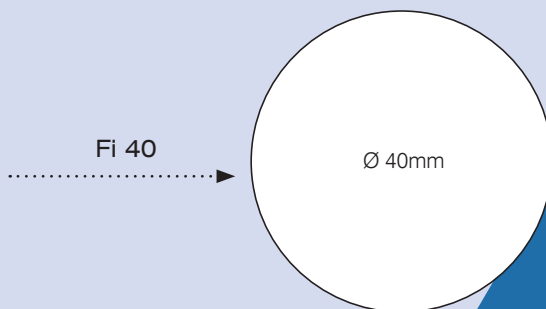
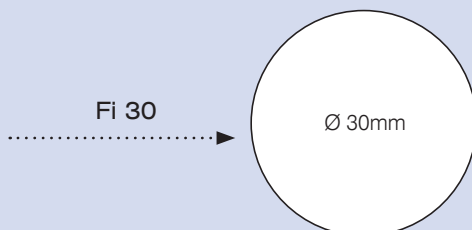
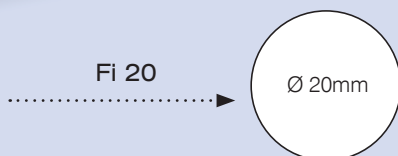

**un timbro tondo con la cover**

## Tamponi di ricambio

Colori d'inchiostro a scelta:  
nero, rosso, blu, verde, viola

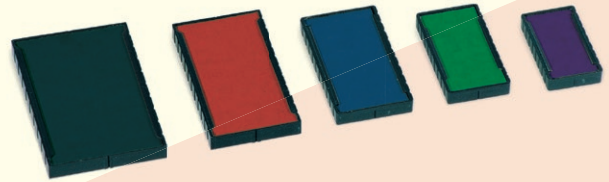
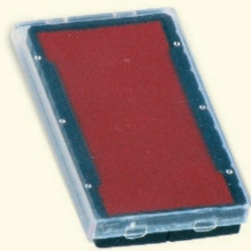

Esiste la possibilità di utilizzare diversi colori d'inchiostro per l'impronta del testo e per l'impronta della data nei datari Wagraf D230 e D240

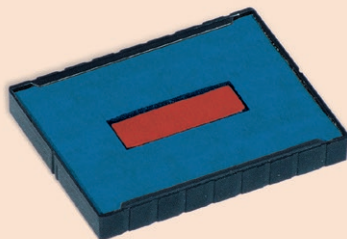

### TAMPONI NON INCHIOSTRATI

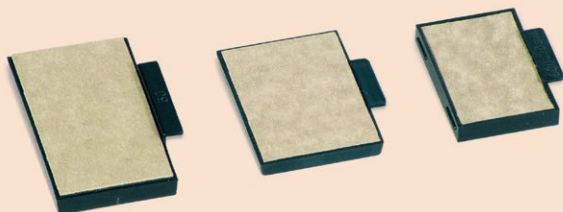

1	WAGRAF 1	28x10mm	■ ■ ■ ■ ■
2	POLAN 1 WAGRAF b1 DATUS	30x12mm	■ ■ ■ ■ ■
3	POLAN 2 WAGRAF b2 WAGRAF 2	38x14mm	■ ■ ■ ■ ■
4	POLAN 3 WAGRAF b3 WAGRAF 3	47x18mm	■ ■ ■ ■ ■
6	POLAN 4 WAGRAF b4 WAGRAF 4	58x22mm	■ ■ ■ ■ ■
7	POLAN 5	70x26mm	■ ■ ■ ■ ■
8	POLAN 55 POLAN D55	42x34mm	■ ■ ■ ■ ■
9	POLAN 6	69x29mm	■ ■ ■ ■ ■
10	POLAN 7 POLAN D7	60x40mm	■ ■ ■ ■ ■
11	POLAN 8	75x40mm	■ ■ ■ ■ ■
12	Fi 30	Ø 30mm	■ ■ ■ ■ ■
13	Fi 40, Fi D40	Ø 40mm	■ ■ ■ ■ ■
14	WAGRAF D230 WAGRAF 230	43x35mm	■ ■ ■ ■ ■
15	WAGRAF D240 WAGRAF 240	60x40mm	■ ■ ■ ■ ■
16	HUZAR 20	39x14mm	■ ■ ■ ■ ■
17	HUZAR 30 HUZAR D30	42x30mm	■ ■ ■ ■ ■
18	HUZAR 40	55x23mm	■ ■ ■ ■ ■
19	HUZAR 50	58x30mm	■ ■ ■ ■ ■
20	HUZAR 60	70x24mm	■ ■ ■ ■ ■
21	HUZAR 80 HUZAR D80	70x48mm	■ ■ ■ ■ ■
22	WAGRAF 100	25x42mm	■ ■ ■ ■ ■
23	HUZAR 65 HUZAR 140	58x35mm	■ ■ ■ ■ ■



# Timbri auto inchiostranti sali scendi in plastica



WAGRAF 230



Le montature auto inchiostranti wagraf 230, wagraf 240 sali scendi in plastica, sono disponibili in 9 colori diversi.

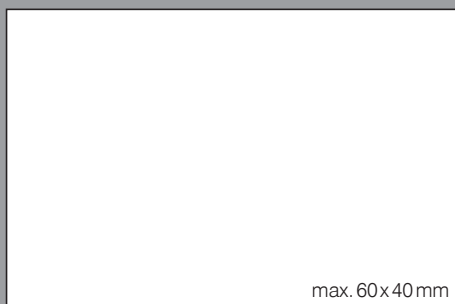

WAGRAF 240



**un modo leggero di timbrare**

# wagraf®

## Timbri auto inchiostranti in metallo

### huzar®



### huzar®

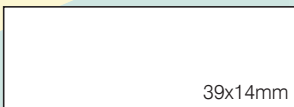

HUZAR 20

39x14mm

### huzar®

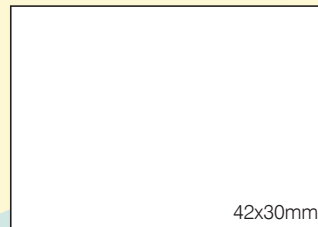

42x30mm

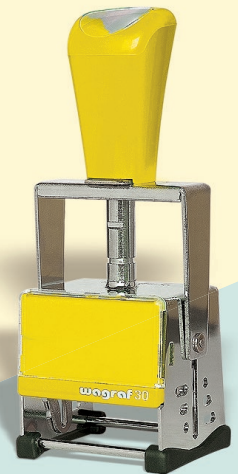

HUZAR 30



HUZAR 40

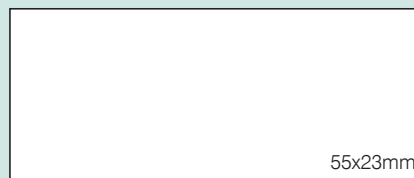

55x23mm

### huzar®



58x30mm

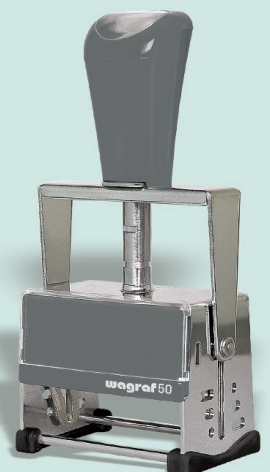

HUZAR 50

Huzar® è l'ultimo modello di timbro auto inchiostrente, registrato nell'Ufficio Brevetti della Repubblica di Polonia al Nr P-368177 ed è protetto negli stati membri dell'Unione Europea e negli Stati Uniti dal 24.05.2004.



HUZAR 60

**huzar®**



70x24mm



HUZAR 65

**huzar®**



58x35mm



HUZAR 80

**huzar®**



70x48mm

HUZAR 20	metallo	39x14mm
HUZAR 30	metallo	42x30mm
HUZAR 40	metallo	55x23mm
HUZAR 50	metallo	58x30mm
HUZAR 60	metallo	70x24mm
HUZAR 65	metallo	58x35mm
HUZAR 80	metallo	70x48mm

**il modo solido di timbrare**

## Timbri tascabili in metallo

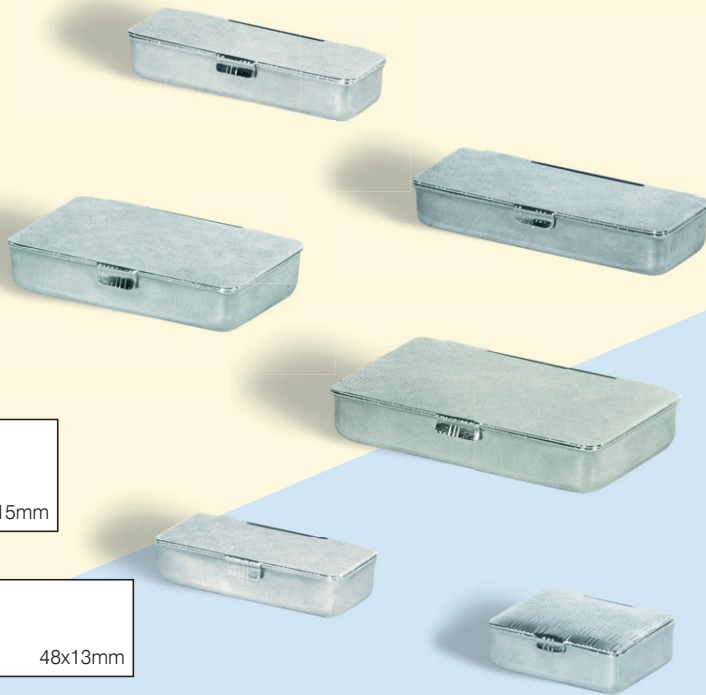

Timbro tascabile	no. 1	38x15mm
Timbro tascabile	no. 1,5	48x13mm
Timbro tascabile	no. 1 3/4	38x20mm
Timbro tascabile	no. 2 I	48x17mm
Timbro tascabile	no. 2 II	46x18mm
Timbro tascabile	no. 2,5	48x20mm
Timbro tascabile	no. 2 3/4 I	48x23mm
Timbro tascabile	no. 2 3/4 II	50x28mm
Timbro tascabile	no. 3	58x19mm
Timbro tascabile	no. 3,5	58x23mm
Timbro tascabile	no. 4	58x26mm
Timbro tascabile	no. 4,5	60x34mm
Timbro tascabile	no. 5	50x50mm
Timbro tascabile	no. 0	26x23mm
Timbro tascabile	no. 01	31x31mm

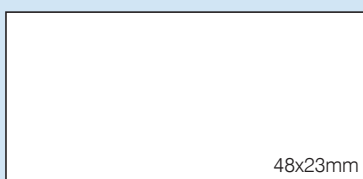
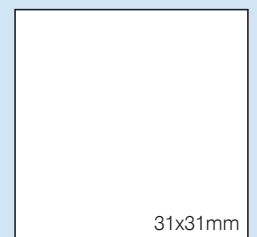
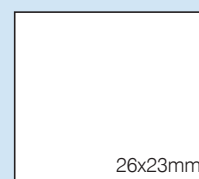
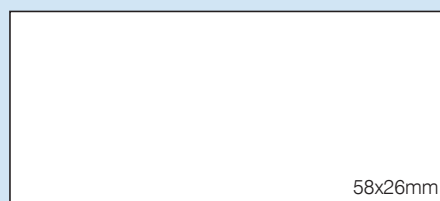
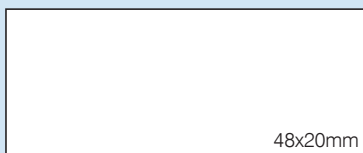
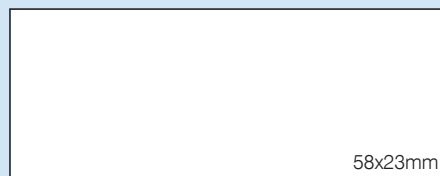
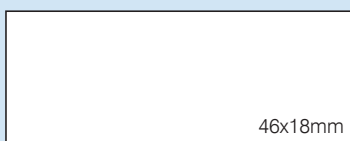
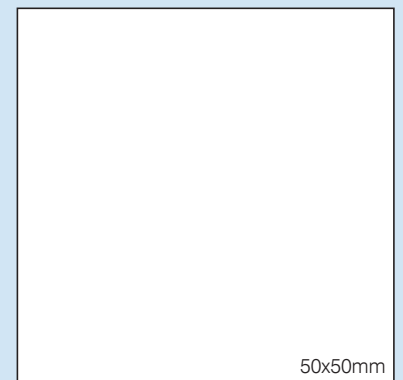
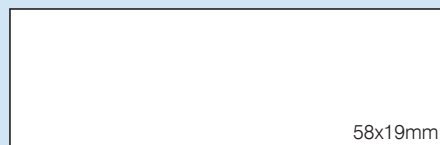
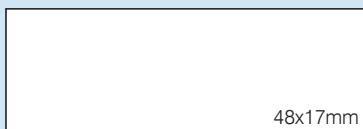
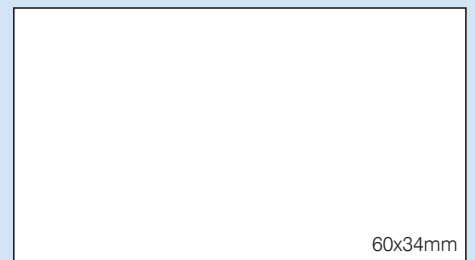
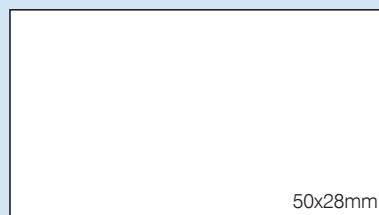
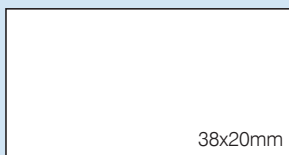
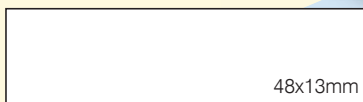
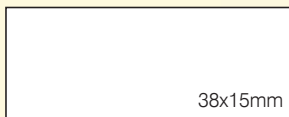

# Timbri tascabili in plastica

Timbro tascabile	no. 27	40x15mm
Timbro tascabile	no. 28	50x20mm
Timbro tascabile	no. 29	58x22mm
Timbro tascabile	no. 33	40x15mm
Timbro tascabile	no. 34	49x19mm
Timbro tascabile	no. 35	60x23mm



TIMBRO TASCABILE no. 27

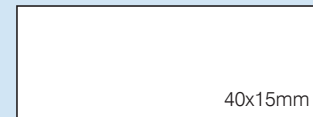

TIMBRO TASCABILE no. 28

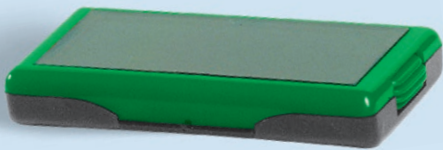
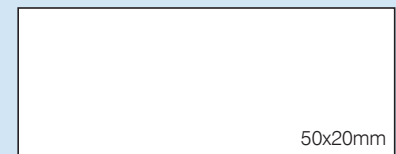

TIMBRO TASCABILE no. 29

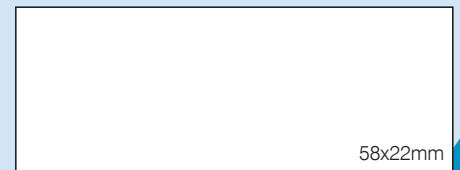

**NOVITÀ**



TIMBRO TASCABILE no. 33

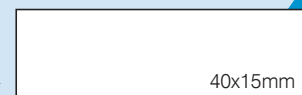

**NOVITÀ**



TIMBRO TASCABILE no. 34



**NOVITÀ**



TIMBRO TASCABILE no. 35



**un timbro in mano**

## Datari e numeratori auto inchiostranti in plastica

I datari automatici in plastica permettono di inserire nell'impronta del timbro la data e il testo.

DATUS	senza piastra	22x3mm
NUMERATORE	senza piastra	22x3mm
WAGRAF D 230		43x36mm
WAGRAF D 240		60x40mm

Nei datari automatici con struttura in plastica D230 i D240 i componenti in plastica vengono offerti in 9 colori diversi



Esiste la possibilità di utilizzare diversi colori d'inchiostro per l'impronta del testo e della data.



DATUS  
senza piastra



NUMERATORE  
senza piastra



WAGRAF D 230

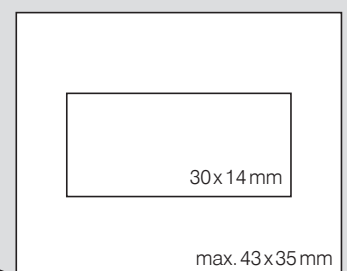

WAGRAF D 240

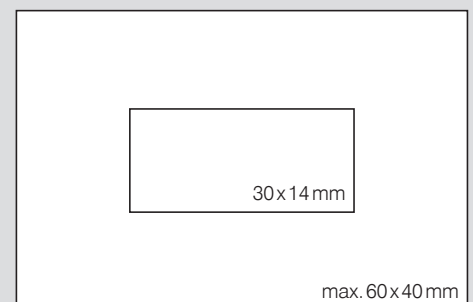

# Datari auto inchiostranti tondi *fi* D40

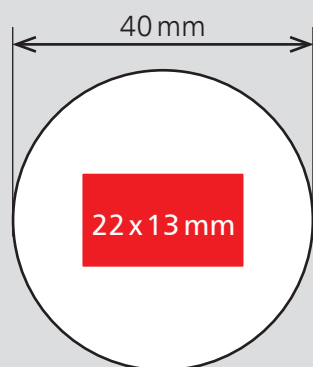

Fi 40



**il datario tondo con la cover**

## Datari e numeratori auto inchiostranti sali scendi in metallo



WAGRAF 110  
senza piastra

WAGRAF 100		42x25mm
WAGRAF 110	senza piastra	
WAGRAF 110 numeratore altezza carattere	senza piastra	22x4mm
HUZAR 140		58x35mm
HUZAR D 30		42x30mm
HUZAR D 80		70x48mm

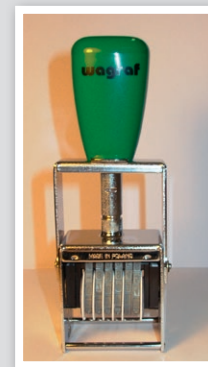

WAGRAF 110  
numeratore

22x4mm



WAGRAF 100

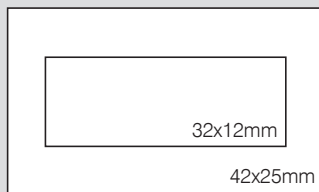

HUZAR D 30

**huzar®**

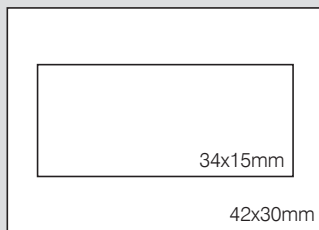

HUZAR 140

**huzar®**

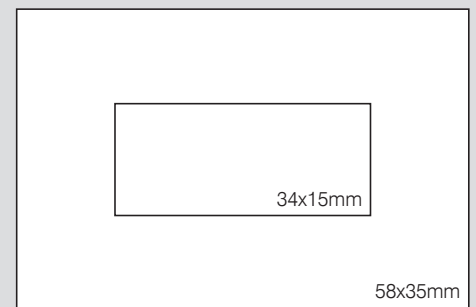

HUZAR D 80

**huzar®**

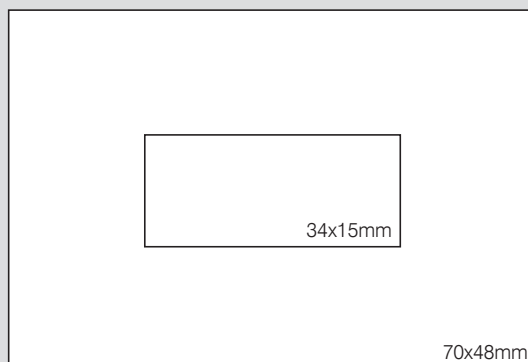

I datari automatici in metallo permettono di inserire nell'impronta del timbro:

- la data
- testo.



# Macchine flash per timbri preink

MQ B1308 1 lampada



MQ B1409 2 lampade



un lavoro veloce

## Timbri preink in 5 minuti

WAGRAF a2	preink	40x15mm
WAGRAF a3	preink	49x19mm
WAGRAF a4	preink	60x23mm



WAGRAF a2

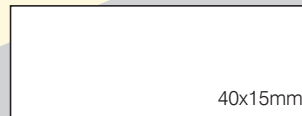

WAGRAF a3

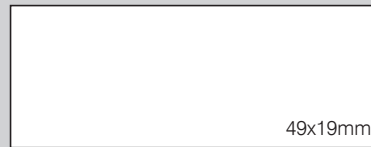

WAGRAF a4



Le gomme e i tamponi di ricambio per timbri a4 e 32, a3 e 31, a2 e 30 sono uguali.



# Timbro preink tascabile in 5 minuti

Tascabile no. 30	preink	40x15mm
Tascabile no. 31	preink	49x19mm
Tascabile no. 32	preink	60x23mm

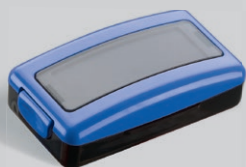

TASCABILE no. 30

40x15mm

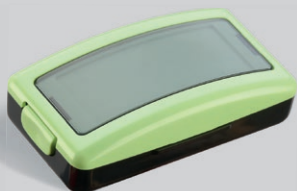

TASCABILE no. 31

49x19mm



TASCABILE no. 32

60x23mm

Le gomme e i tamponi  
di ricambio per timbri  
a4 e 32 ,  
a3 e 31,  
a2 e 30  
sono uguali.

...un timbro in mano

## Timbri manuali in plastica

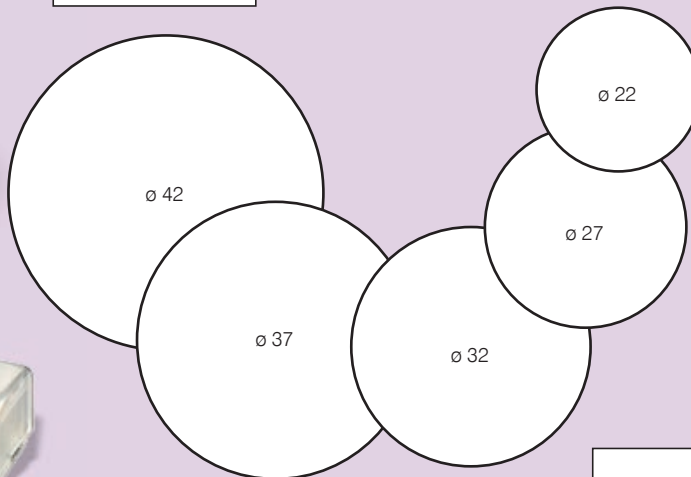
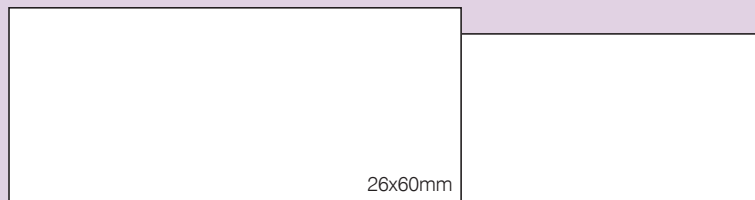
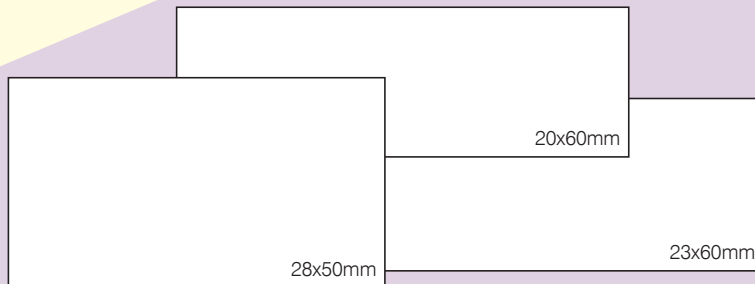
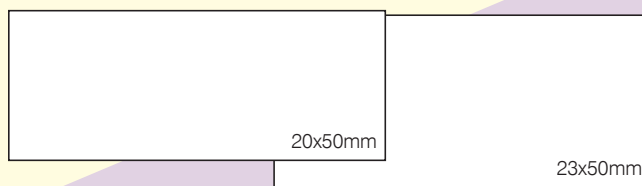
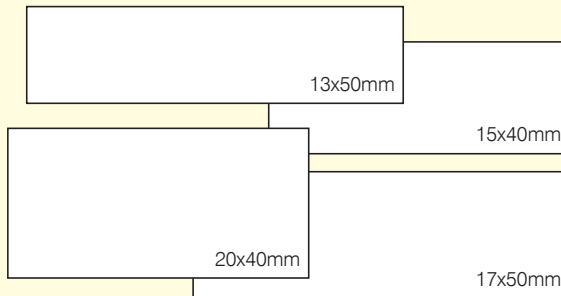

Timbro manuale	no. 1	15x40mm
Timbro manuale	no. 1,5	13x50mm
Timbro manuale	no. 1 3/4	20x40mm
Timbro manuale	no. 2	17x50mm
Timbro manuale	no. 2,5	20x50mm
Timbro manuale	no. 2 3/4	23x50mm
Timbro manuale	no. 2 3/4 II	28x50mm
Timbro manuale	no. 3	20x60mm
Timbro manuale	no. 3,5	23x60mm
Timbro manuale	no. 4	26x60mm
Timbro manuale	no. 4,5	34x60mm
Timbro manuale	no. 0	18x27mm
Timbro manuale	no. 740	7x40mm
Timbro manuale	no. 745	7x45mm
Timbro manuale	no. 750	7x50mm
Timbro manuale	no. 755	7x55mm
Timbro manuale	rotunda	ø 22
Timbro manuale	rotunda	ø 27
Timbro manuale	rotunda	ø 32
Timbro manuale	rotunda	ø 37
Timbro manuale	rotunda	ø 42
Timbro manuale	no. 1040	10x40mm
Timbro manuale	no. 1045	10x45mm
Timbro manuale	no. 1055	10x55mm
Timbro manuale	no. 1070	10x70mm

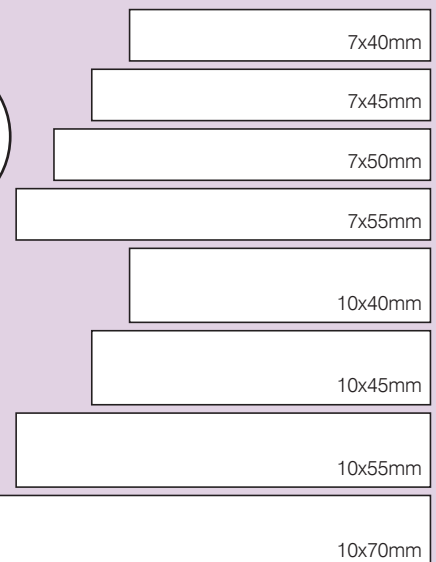

Timbro manuale	no. 4075	40x75mm
Timbro manuale	no. 4565	45x65mm
Timbro manuale	no. 5555	55x55mm
Timbro manuale	no. 5565	55x65mm
Timbro manuale	no. 5575	55x75mm
Timbro manuale	no. 6565	65x65mm

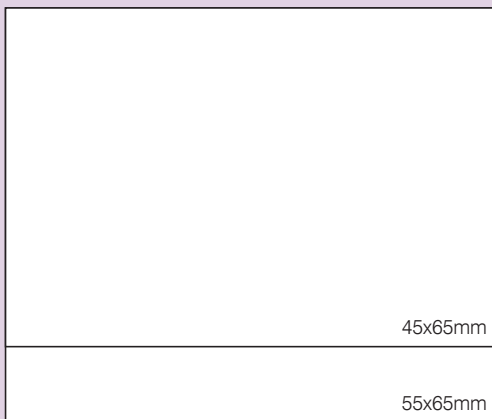
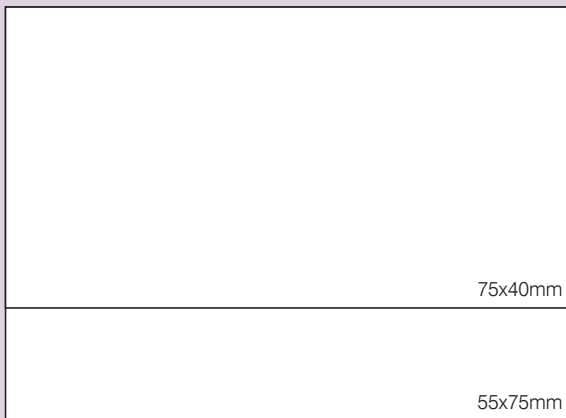

Timbro manuale	no. 7090	70x90mm
Timbro manuale	no. 80100	80x100mm
Timbro manuale	no. 90110	90x110mm

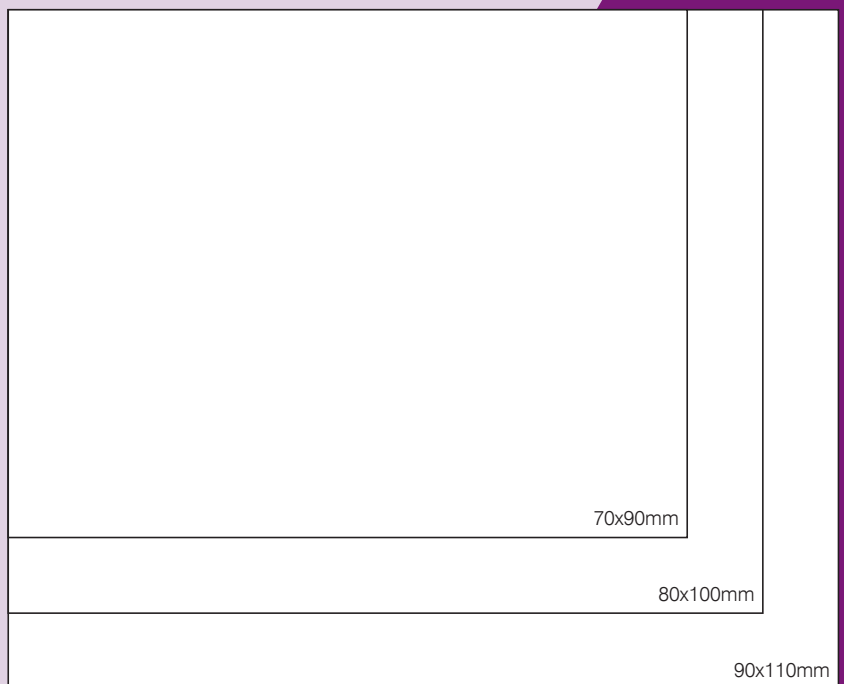
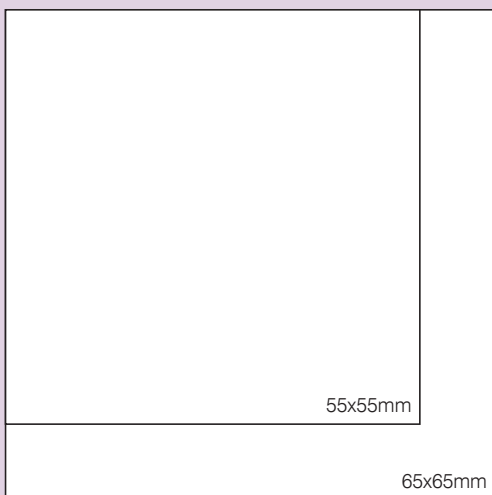

## Cuscinetti per timbri

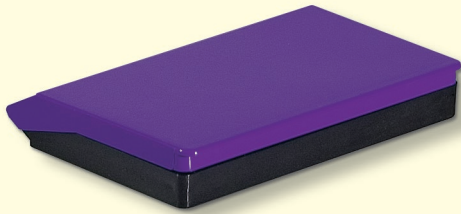

PM  
cuscinetto piccolo (in plastica) – 50 x 85 mm

Cuscinetti in plastica  
PD, PS, PM  
sono impregnati di inchiostro.

Il colore del coperchio indica  
il colore dell'inchiostro  
(nero, azzurro, rosso, viola, verde).

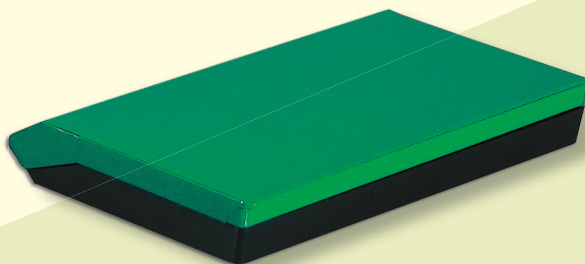

PS  
cuscinetto medio (in plastica) – 70 x 110 mm

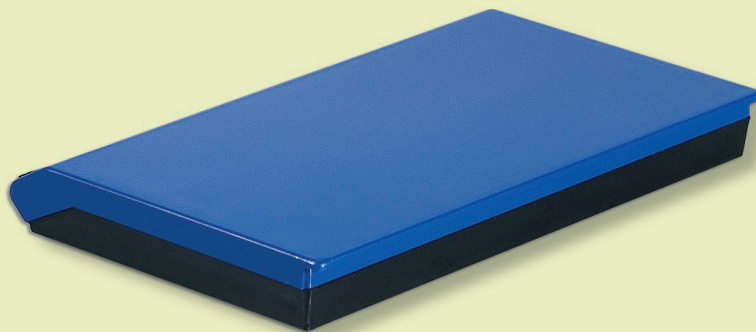

PD  
cuscinetto grande (in plastica) – 85 x 155 mm



PMD  
cuscinetto in metallo grande – 190 x 110 mm

Cuscinetto in metallo PMD  
è un cuscinetto non preinchiostro  
da impregnare con l'inchiostro  
in modo autonomo.

# Timbri manuali a culla in legno e sagome in legno



Misure disponibili  
70 x 100, 80 x 120, 100 x 120 mm  
(Fino esaurimento delle scorte)

## Sagome in legno leggero



Le sagome in legno sono disponibili nel seguenti misure:  
lunghezza 50 cm  
larghezza 8, 10, 15, 20, 25, 30, 35, 40, 50, 60, 70, 80, 90, 100, 120, 140 mm

## Materiali di consumo



Polimero liquido I55HV trasparente disponibile in bottiglie da 1kg e 2kg.



Post esposizione sale 350 gr



Film base A4 100 fogli  
Film base A4 100 fogli adesivo



UV pellicola luce ambiente



Cover film roll 31,5 cm x 180 m



Svillupatore 1 kg



Fissatore 1 kg



Detergente classico 5 kg  
Detergente super 1 kg





Anneritore spray 400 ml



Film per la stampante laser 100 fogli A4



Nastro biadesivo per timbri trasparente a retina 50 mm x 10 m

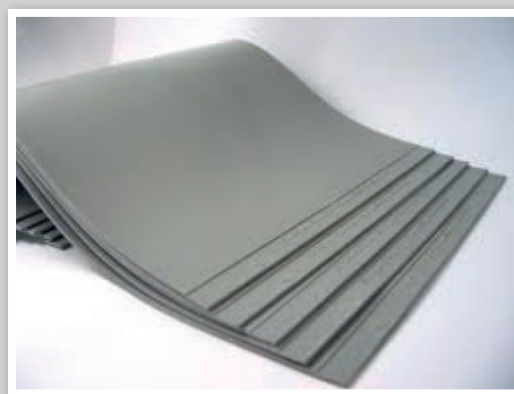

Gomma laser inodore grigia A4 (la polvere d'incisione resta attaccata alla gomma)



Profilo di spugna da 1, 6mm x 2 5m,  
2 mm x 30 m, 3 mm x 30 m



Inchiostri per timbri a polimero 25 ml  
disponibile in 5 colori

## Materiali di consumo per timbri Preink



Film protettivo

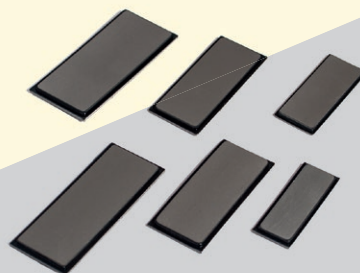

Gommine ricambio



L'inchiostro per i timbri preink da 30ml disponibile in 5 colori.



Tamponi di ricambio a colori per i timbri preink

WAGRAF a2 PORTA TIMBRO no. 30	preink	40x15mm
WAGRAF a3 PORTA TIMBRO no. 31	preink	49x19mm
WAGRAF a4 PORTA TIMBRO no. 32	preink	60x23mm

# Macchine per timbri a polimero



Vasca ad ultrasuoni per lavaggio del polimero formato A3, A4, A5



Macchina per timbri

**una grande macchina  
ad un piccolo prezzo**

## **ABBO**

Via Cervese nr. 1425  
47521 CESENA ( FC )  
tel., FAX 0547-481739  
e-mail: [info@abboincisioni.it](mailto:info@abboincisioni.it)  
[www.abboincisioni.it](http://www.abboincisioni.it)

